



**HEAT & GLO™**

No one builds a better fire



**SlimLine® Series**  
Gas Fireplaces



A



B

Less space  
& more options



C

**Cover: SL-350TRS** shown with Kenwood corner cabinet, optional raised hearth base, absolute black granite and Halston operable doors in graphite

**A. SL-550TRS** shown with Kenwood wall cabinet, optional raised hearth base, marron brown marble and Halston operable doors in new bronze

**B. SL-750TR** shown with Laurent mantel and hearth and Aero front in new bronze

**C. SL-950TR** shown with Kenwood mantel, New Venitian Gold granite and Chateau Deluxe front in graphite

The SlimLine Series—fireplaces that take up little space but give you lots of options, and a lot for your money. They're all about value, size and heat options.

**Value** because the Series is the best in its class, while remaining absolutely affordable.

**Space** because the shallow 16-1/4" depth goes practically anywhere. And four different widths provide an option for rooms cozy to great.

**Heat Options** because the Series offers models with varying heat outputs for different needs.



**SL-550TR** shown with Kenwood mantel, wheatfield granite and Clean Face Kit

# SlimLine<sup>®</sup> Series

Value, Space and Heat Options

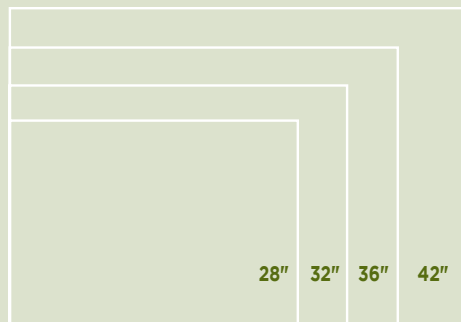

With so many options, you've got some choices to make: the width, model, front and mantel system.

## Determine the width.

Choose from four widths—28", 32", 36" and 42". The right size for the wall and room is important. A fireplace that's too small looks disproportionate. A fireplace that's too big can overheat the room. Your salesperson can help you determine the best fit.



## Choose a model.

**TRS models:** Offer the Series' best flame, with an advanced ceramic burner and refractory, plus richly detailed logs. They generate the most heat and are AFUE rated for high efficiency.

**TR models:** Provide a full flame and realistic log set. They generate a moderate level of heat.

Options, options  
& more options



## Select a front.

Choose from three fronts—each available in black, graphite and new bronze

### Aero Front

INSIDE FIT



### Chateau Deluxe Front

OVERLAP FIT



### Halston Operable Doors

OVERLAP FIT



### FINISHES

Choose from three beautiful finishes



Black



Graphite

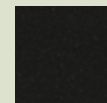

New Bronze

Chateau Deluxe Front and Halston Operable Doors completely overlap surround materials for a clean look. Adjustable hinges allow for variations in the thickness of surround materials of up to 1".

### Chateau Deluxe Front for SL-350 Model



### CLEAN FACE KIT

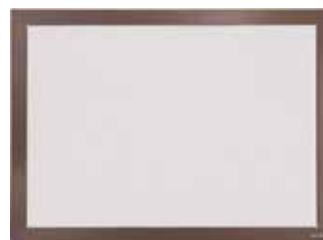

Works with SL-550TR and SL-750TR and comes with its own front.

Allows surround materials like brick, stone and tile to come flush to the firebox edge for a cleaner finish.

## Pick a mantel system.

Whether your style is traditional, transitional or modern, finishing your fireplace couldn't get any easier.



**Kenwood flush mantel**  
Shown with SL-550TR



**Kenwood flush mantel with optional raised hearth base** Shown with SL-750TRS



**Kenwood wall or corner cabinet with optional raised hearth base** (not available on 950 models) Shown with SL-350TRS



**Laurent cast mantel and hearth** (not available on 350 models) Shown with SL-750TR

## Modern Collection Surrounds for SL-550TR and SL-750TR

Use with Aero front only



**Echo** with SL-550TR



**Luna** with SL-750TR

## Mantels for SL-750 Models only



**Portico** in painted maple with Marron Brown marble



**Sonoma** in knotty alder with Caledonia granite



**Parsons** in chocolate alder with St. Cecilia medium granite

### THE KENWOOD

Available three ways—flush mantel, wall cabinet or corner cabinet. Add a raised hearth base to any option. Available in primed wood, ready to be painted.

### THE LAURENT

Its graceful shape and matching curved hearth are formed from a cast material, ready to be painted.

## MANTEL OPTIONS - shown unfinished

Featuring mantels and surrounds by Fireside Furnishings, the Slimline series has a broad selection of wood and cast hearth design solutions available to finish around and showcase the beautiful fire.



## NATURAL STONE OPTIONS

Complete your hearth system with a variety of natural stone options from our Select, Signature or Designer Series of surrounds.

### Select Series



### Signature Series

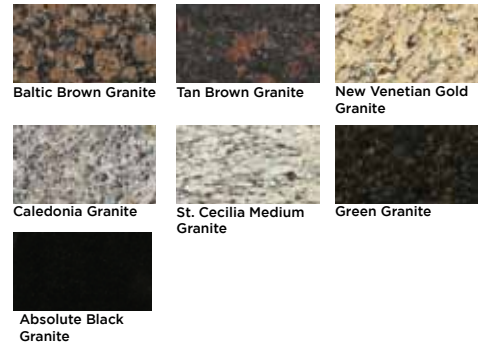

### Designer Series



Actual product appearance, including flame, may differ from product images.

# SlimLine Mantels and Cabinets

## Kenwood Flush Mantel and Optional Raised Hearth Base

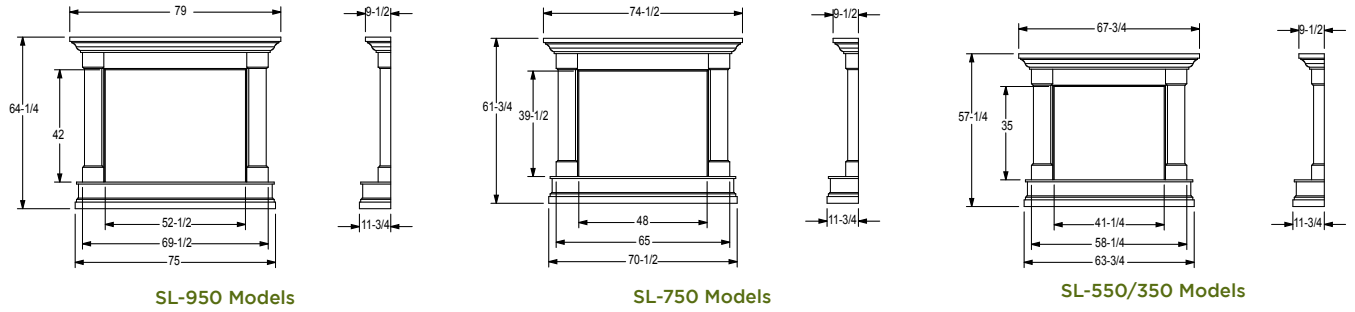

## Kenwood Flush Cabinet and Optional Raised Hearth Base

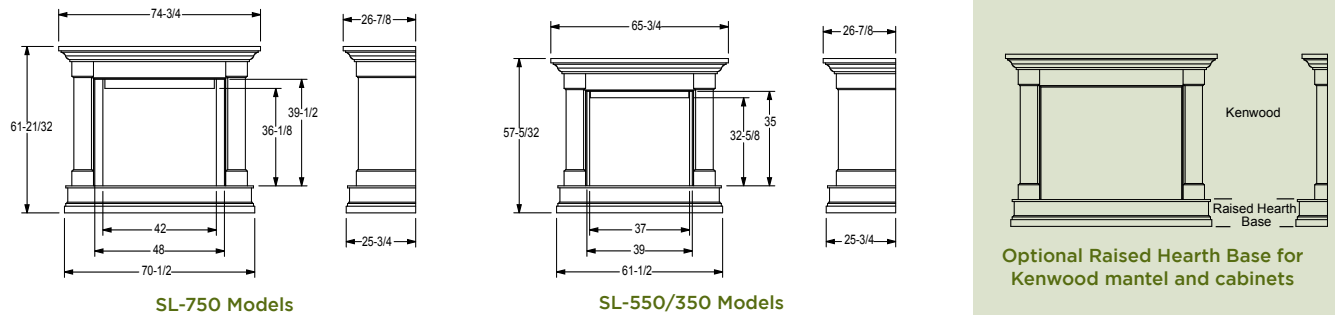

## Kenwood Corner Cabinet and Optional Raised Hearth Base

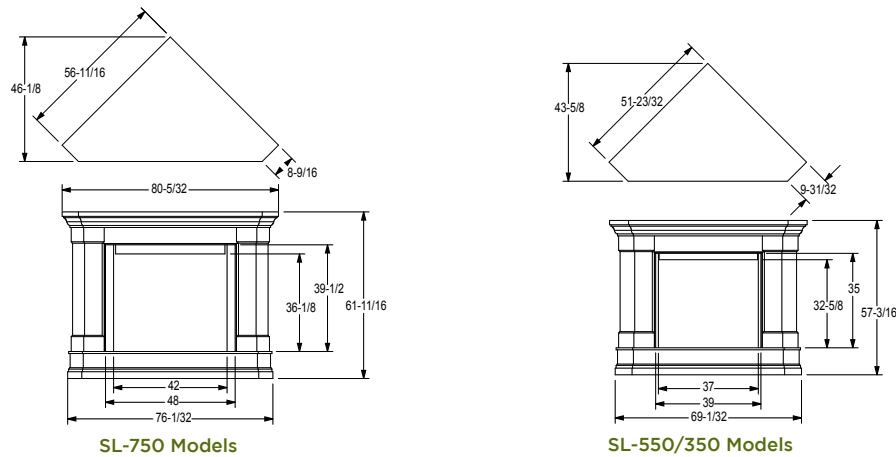

## Laurent Cast Surround

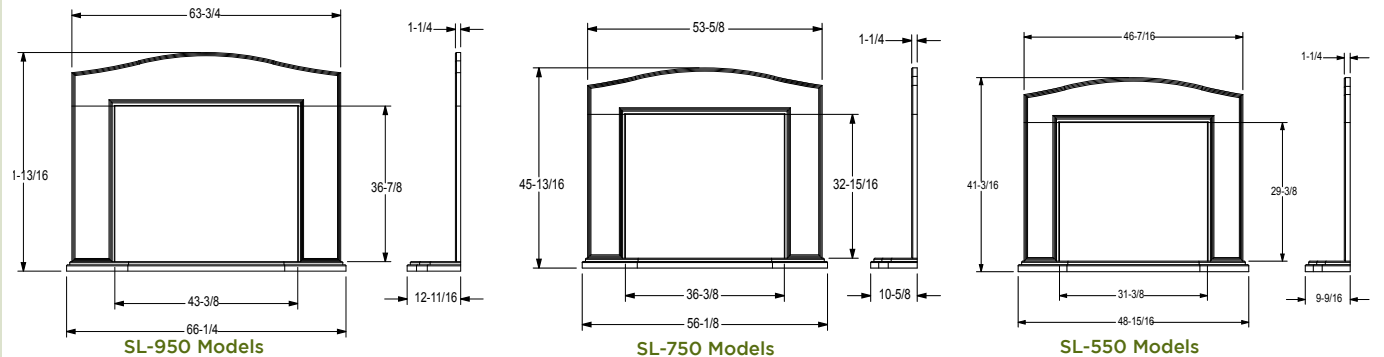

## SlimLine Specifications

MODEL	HEIGHT		FRONT WIDTH		BACK WIDTH		DEPTH		GLASS SIZE	BTU/HOUR INPUT (NG)
	Actual	Framing	Actual	Framing	Actual	Framing	Actual	Framing		
SL-350TRS	32-3/8	32-3/4	33	34	22-3/4	34	16-1/4	16-1/4	27-1/2 x 19	14,400-20,500
SL-550TR & TRS	34-3/8	34-3/4	36	37	25-3/4	37	16-1/4	16-1/4	30-1/2 x 21	18,200-27,300 (TRS) 15,000-21,000 (TR)
SL-750TR & TRS	37-7/8	38-1/4	40-7/8	42	30-3/4	42	16-1/4	16-1/4	35 x 24-1/2	20,200-30,800 (TRS) 16,900-24,300 (TR)
SL-950TR	41-7/8	42-1/4	48	49	37-3/4	49	16-1/4	16-1/4	43 x 22	20,900-30,400

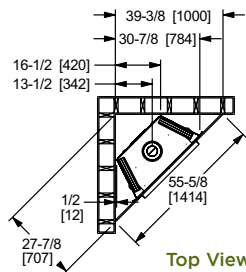

Top View Corner Installation

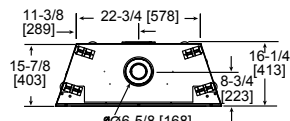

Top View

SL-350TRS

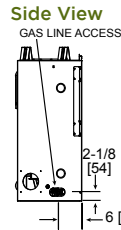

Side View

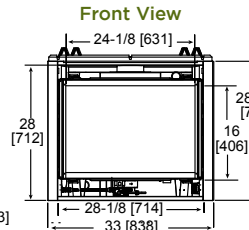

Front View

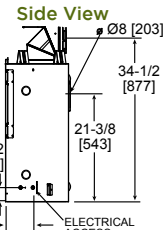

Side View

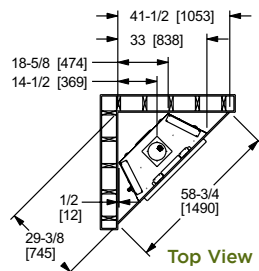

Top View Corner Installation

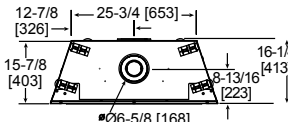

Top View

SL-550TR & TRS

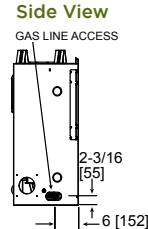

Side View

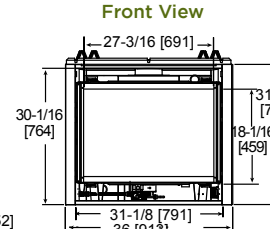

Front View

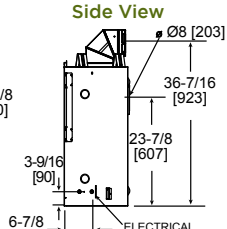

Side View

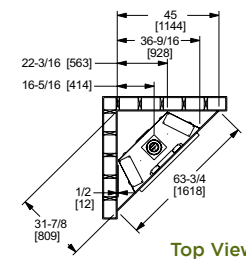

Top View Corner Installation

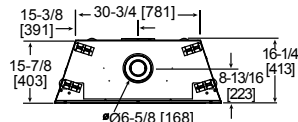

Top View

SL-750TR & TRS

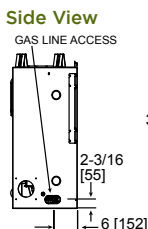

Side View

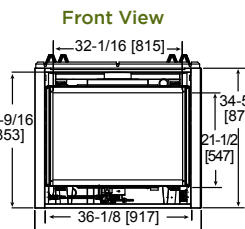

Front View

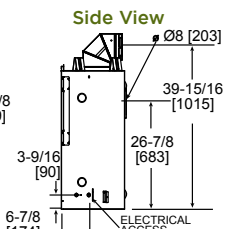

Side View

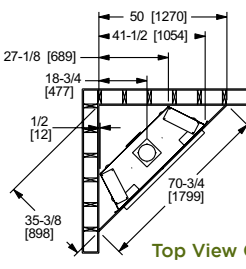

Top View Corner Installation

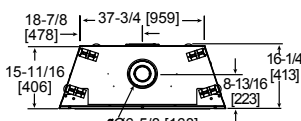

Top View

SL-950TR

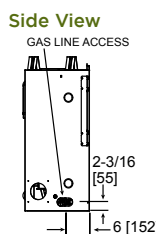

Side View

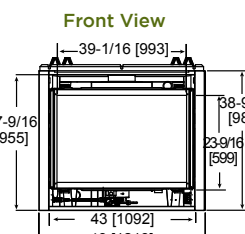

Front View

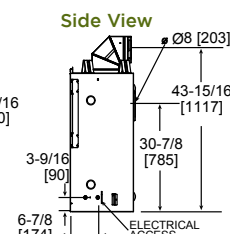

Side View

Dimensions above are in inches and millimeters. Product information is not complete and is subject to change without notice. Product installation must adhere strictly to instructions shipped with product. We recommend measuring individual units at installation. Assumes the use of 1/2" sheetrock. NOTE: Combustible material should not cover the face. Make sure you do NOT cover the decorative door opening.

Refer to installation manual for detailed specifications on installing this product. Heat & Glo reserves the right to update units periodically. The flame and ember appearance may vary based on the type of fuel burned and the venting configuration used. Actual product appearance, including flame, may differ from product images.

### Healthy Hearth

Our direct vent fireplaces will not alter the quality of indoor room air in any way. They utilize a sealed combustion chamber that draws in fresh air from outdoors and discards all combustion by-products back outside.

### IntelliFire™

Our exclusive, state-of-the-art, "green friendly" IntelliFire ignition system reduces gas consumption and thermogenerator wear by providing a pilot flame only when needed. It also supplies a back-up battery system to run the fireplace during a power outage.

### Limited Lifetime Warranty\*\*

The strongest in the industry, Heat & Glo provides a limited lifetime warranty on gas-burning products for their most important aspects: firebox and heat exchanger.

\*\*For full warranty details go to [www.heatnglo.com](http://www.heatnglo.com)



## SlimLine Model Comparison

MODEL	TECHNOLOGY	VIEWING WIDTH	SETTING
SL-350	TRS	28"	Ideal for corners or between windows
SL-550	TRS or TR	32"	Sized perfectly for an owner's suite or den
SL-750	TRS or TR	36"	A great choice for a great room
SL-950	TR	42"	Designed to be proportional to larger rooms

## SlimLine Model Features

FEATURES	SL-350TRS	SL-550TRS	SL-550TR	SL-750TRS	SL-750TR	SL-950TR
AFUE Rated	•	•		•		
Heater Rated			•		•	•
Brick Refractory Kit	optional	standard	optional	standard	optional	optional
Sealed Combustion Chamber	•	•	•	•	•	•
Selection of Decorative Fronts	•	•	•	•	•	•
Optional Fan Kit	•	•	•	•	•	•
Optional Remote Control/Wall Switch	•	•	•	•	•	•
Ceramic Gas Logs	4	5	5	5	5	5
Limited Lifetime Warranty	•	•	•	•	•	•
Top and Rear Direct Vent	•	•	•	•	•	•
IntelliFire™ Ignition System		•	•	•	•	•
Adjustable Valve	•	•	•	•	•	•
Gas Flex Connection	•	•	•	•	•	•
Ceramic Glass	•	•		•		
Tempered Glass			•		•	•



Heat & Glo

*A brand of Hearth & Home Technologies Inc.*

7571 215th Street West

Lakeville, MN 55044

(888) 427-3973 (952) 985-6000

Web: [heatnglo.com](http://heatnglo.com)

For complete information and valuable assistance on this series, please contact us at: